

Xenio™



INSTRUCTION GUIDE FOR XENIO 200

Contents

INTRODUCTION	4
WHAT'S IN THE BOX	5
XENIO TIME CLOCK INSTALLATION	6-8
CONFIGURE WIFI SETTINGS (OPTIONAL)	9-10
CONNECT VIA ETHERNET/NETWORK CABLE	11
HOST PC SETTINGS	12-13
EXPORTING TIME LOGS INTO USB	14-15
ADDING EMPLOYEES	16-19
Adding an Employee's Fingerprint	16-17
Adding a Smart Card to an Employee	18
Adding a Pin Number to an Employee	19
ASSIGNING ADMINISTRATOR/MANAGER LEVEL	20-21
HOW TO PROPERLY CLOCK IN/OUT	22-25
Fingerprint	22
Smart Card	23
Pin Number	24-25
SYSTEM SETTINGS	26-27

This instruction guide covers the configuration for the following model:

XENIO 200

Manual Version 1.0

©Easy Clocking 2018

What's in the box

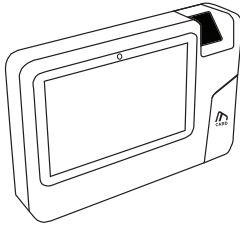

XENIO



**XENIO
INSTRUCTION
GUIDE**

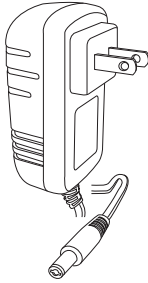

POWER ADAPTER

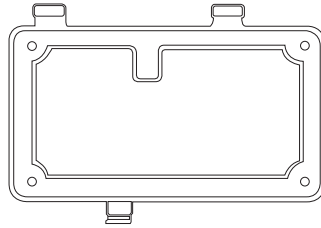

WALL MOUNT

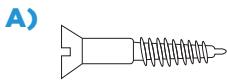

**4x
SCREWS**

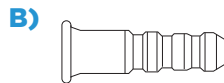

**4x
WALL
ANCHORS**

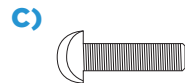

**1x
WALL MOUNT
SCREW**

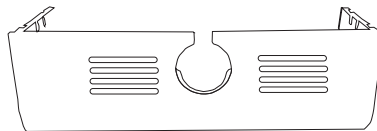

COVER PLATE

Installation

1

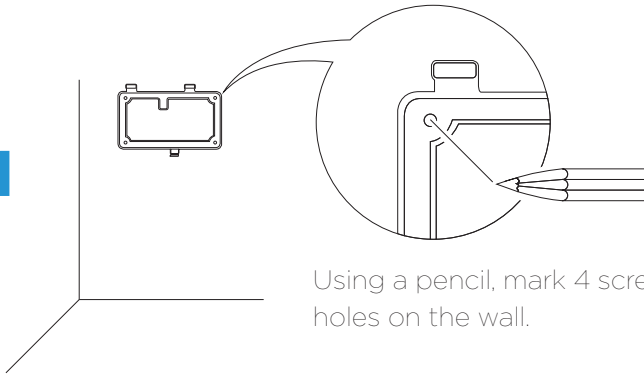

Using a pencil, mark 4 screw holes on the wall.

2

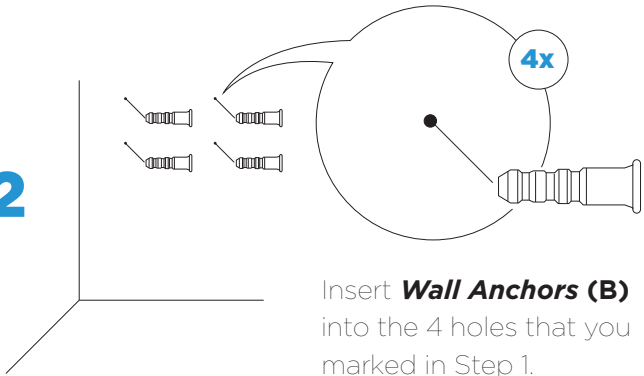

Insert **Wall Anchors (B)** into the 4 holes that you marked in Step 1.

3

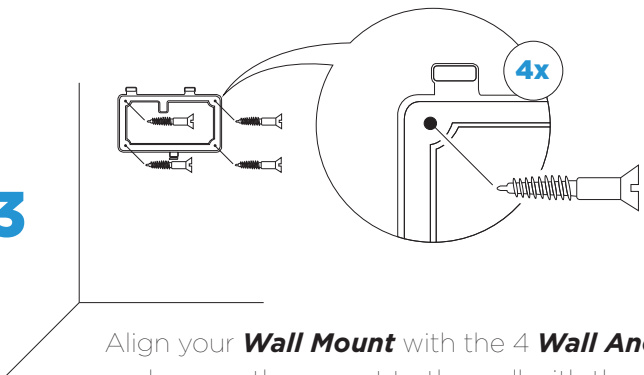

Align your **Wall Mount** with the 4 **Wall Anchors (B)** and secure the mount to the wall with the 4 **Screws (A)** provided.

4

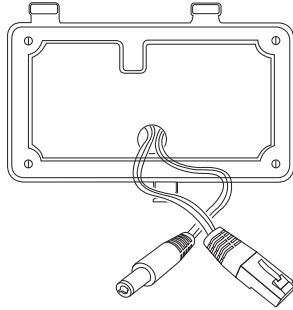

**When connecting to your network via ethernet:
Run the cables (ethernet cable not provided)
inside or outside of the wall.*

5

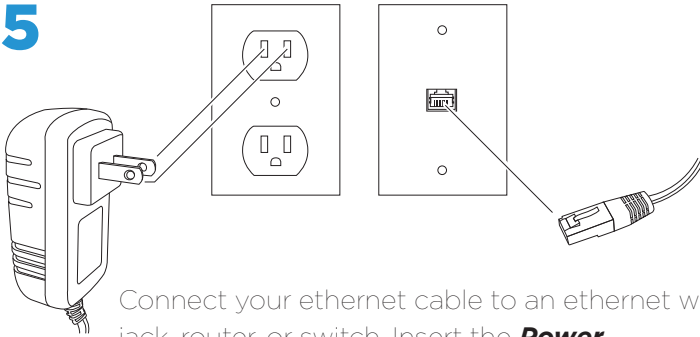

Connect your ethernet cable to an ethernet wall jack, router, or switch. Insert the **Power Adapter** to an electrical receptacle.

6

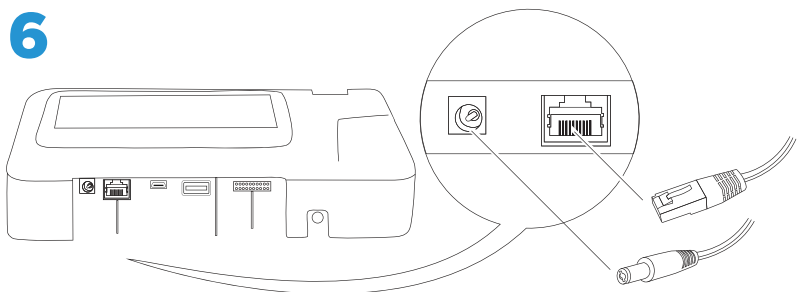

Attach the other end of the ethernet cable and the **Power Adapter** to the Xenio.

** When connecting power to the Xenio via POE, DO NOT connect the provided power adapter.

** Network cable is not required when using WiFi

7

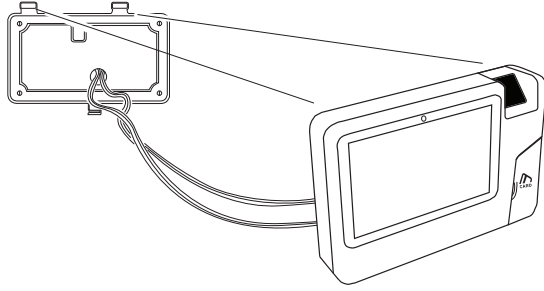

Attach the Xenio to the **Wall Mount**.

8

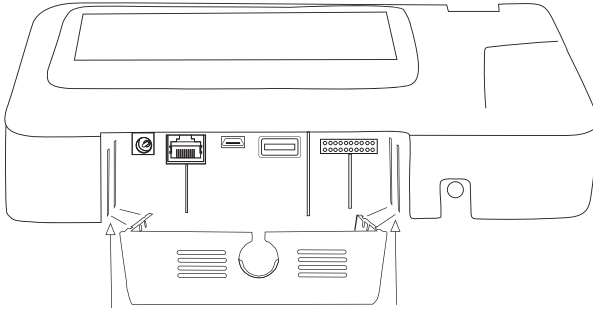

Attach **Cover Plate** (optional) into grooves

9

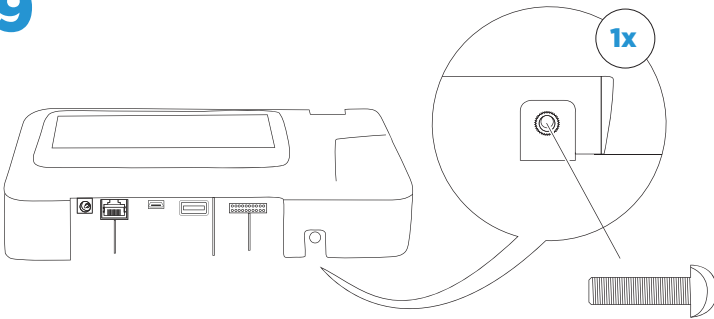

Secure the Xenio to the **Wall Mount** by fastening the **Wall Mount Screw (C)**.

8

Configure Wifi Settings (optional)

1. Open the Xenio Time Clock Menu

Tap 

2. Select *Wi-Fi*

Tap 

3. Enable the Wi-Fi option on the Time Clock

- To enable Wi-Fi, switch the Wi-Fi option from **OFF to ON** located at the top of the screen.

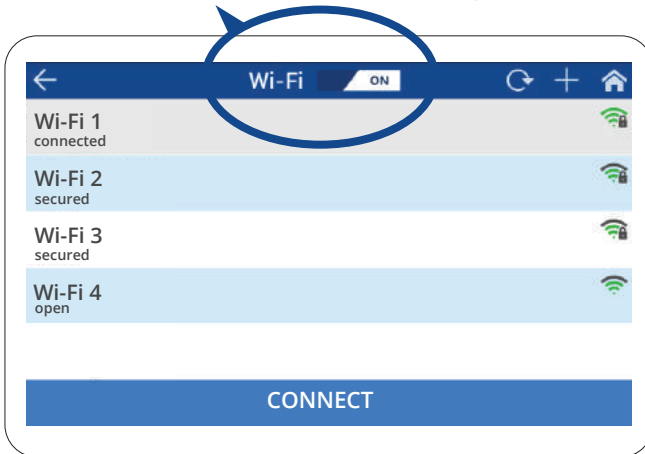

4. Select your Wireless network from the list.
 - If the network is secured, you will need to input your security key/password to successfully connect.
 - If the network is open (no security key/password,) the device will connect automatically.

5. Tap on **CONNECT** located on the bottom right side of the screen to complete the process.



6. Once connected, the status will be displayed below the name of the Wireless network.



- To confirm the *Status*, *Signal Strength*, *Security Type* and *IP address*, simply select the network once again from the list. You will also be able to **FORGET** the network from this screen.

Connect via Ethernet/Network Cable

** When using this connection method make sure the WIFI is turned off

1. Open the Xenio Time Clock Menu

Tap 

2. Select *Ethernet*

Tap 

3. The Xenio has been pre-configured to use *DHCP*. This will automatically assign an available IP Address on your network

- If you choose to configure the clock to use a *Static IP*, you will need to change the setting from *DHCP* to *Static*.
- Once you have specified *Static*, you will be able to input your Static IP Address, Default Gateway and Subnet Mask (pre-configured to 255.255.255.0)

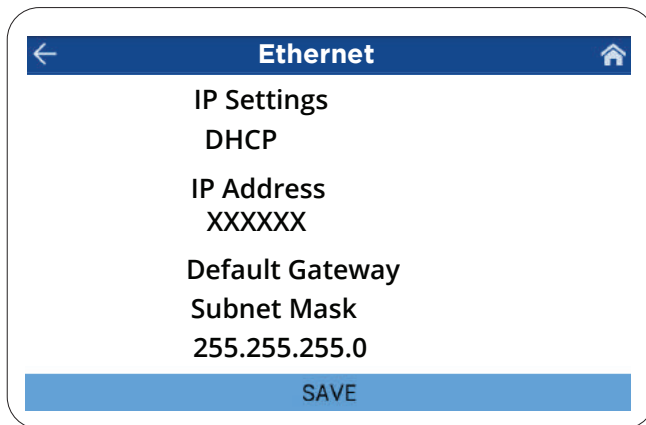

4. Select **SAVE** to complete to process

Host PC Settings

Cloud Software



If you are using our cloud-based software (SaaS), the Time Clock Host PC Settings have been pre-configured. All you need to do is connect the Xenio to any internet connection, as previously explained by either Wi-Fi or Ethernet..

*Any changes to these parameters should be consulted with your network administrator and/or EasyClocking's Technical Support Team.

Installed Software

If you are using our Installed version of the software, you must configure the Time Clock Host PC Settings to point to the server or PC in which you installed the software.

To configure your settings when using our Installed software, first:

1. Obtain the IP address of the Host Server or PC where you have installed the Easy Clocking software.
2. Configure Host IP settings on the Xenio Time Clock
 - Navigate into the Menu 
 - Select Host PC Setting 

*Refer to the image on the next page...

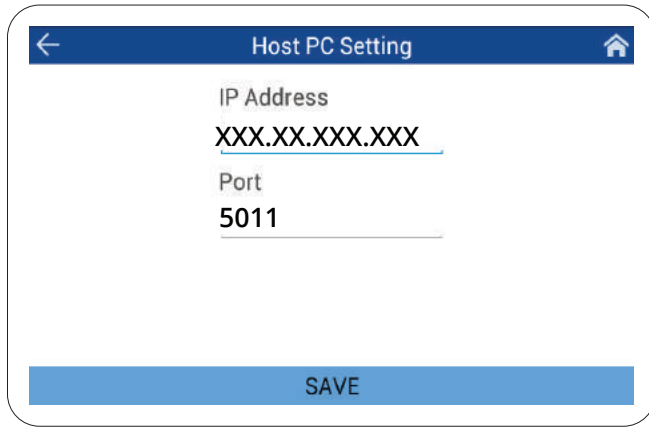



3. Verify the following parameters:

Host PC IP Address: Enter the IP address of the Server or PC in which the Easy Clocking software is installed. Refer back to number 1.

Host PC Port: The time clock communication port for Installed Software is 5011.

4. Select **SAVE** to apply any changes.





This icon represents the connection status between the Xenio Smart Clock and the Server. When the device has not obtained a valid connection to the server, the following icon will display . Once a successful connection has been established, the  will disappear.

Exporting Time Logs into USB

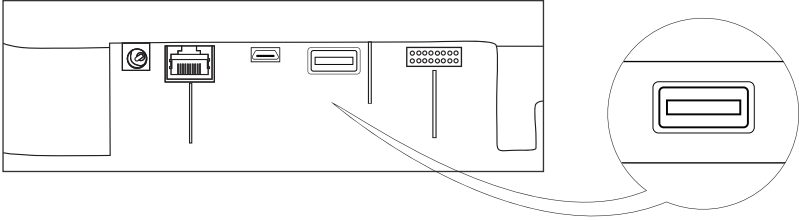
1. Insert a USB flash drive into the USB port located underneath the device.



2. Open the Xenio Time Clock Menu 
3. Select *Settings* 
4. Scroll down and select *Export to USB*

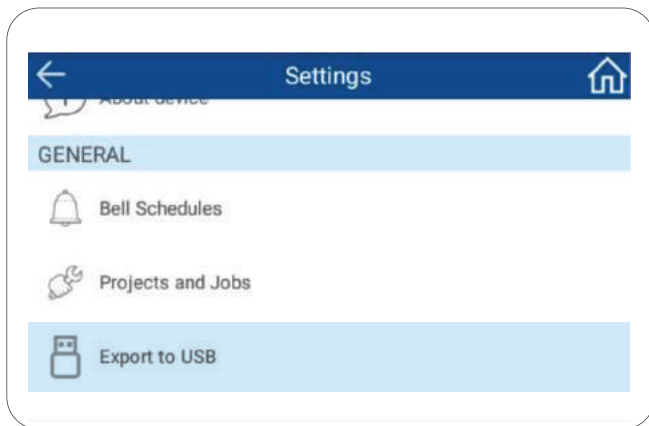

5. You will be prompted to confirm the download of the records.
Select **Yes**

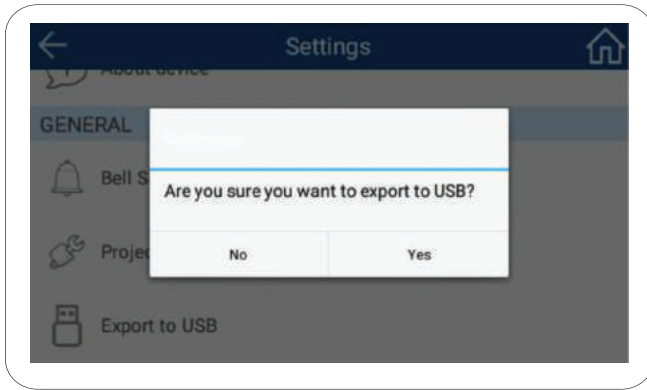

6. Choose from the following options:
- **All:** Used to download ALL attendance records in the device Memory, whether they were downloaded previously or not. (Note: This method will overwrite any previously edited records.)
 - **New:** Used to download only NEW attendance records. (Always recommended)

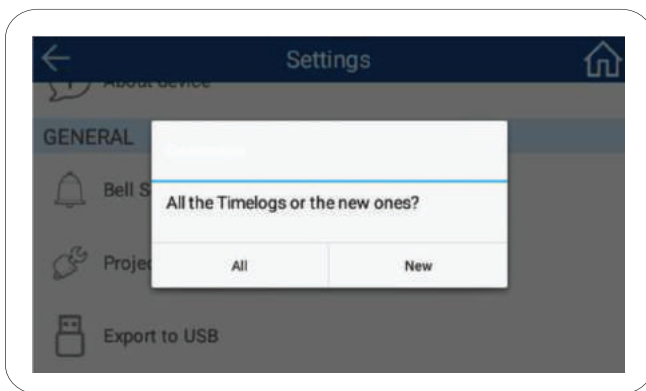

7. A "Downloaded Successfully" message will appear, select **OK**.

NOTE:

Only users with Administrative privileges will be allowed to download the time records using the USB flash drive. To upload the Time Logs, refer to the Online Help Guide

Enrolling Employee Fingerprint Card or Pin Code

To enroll a User on the Xenio Smart Clock, you must first create the User in the EasyClocking software.

In your EasyClocking software:

1. Click on the **Users** tab, then click on the **General** tab.
2. Click on the **Create User** button located to the right of the screen.
3. Enroll the User with their corresponding settings.
4. Assign the User to the device via the **Clocking Permissions**.

Once the User has been successfully enrolled within the software, we can send the Clocking Permissions. Pushing this command will send the User's full name from the software to the Time Clock.

Note:

The Time Clock(s) must be connected to a network in order to receive any commands from the Software.

Enter the Xenio Time Clock's menu

1. Select Users. 
2. Select the User from the list on the left. You may also search for a specific User by tapping on the **Search Box** at the top of the list.

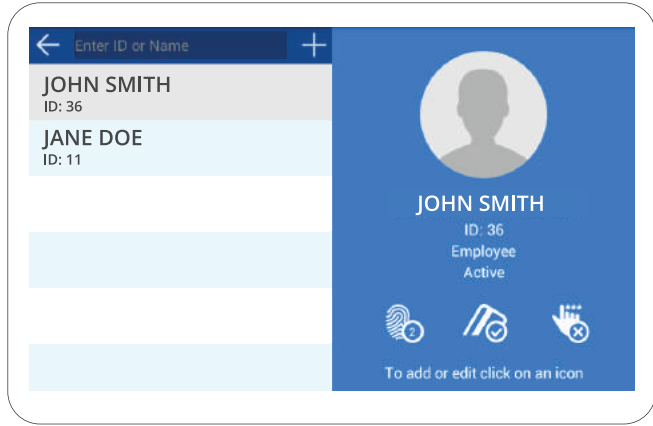

3. *User Authentication:*

Select the method of authentication you wish to add for the user.

I. Fingerprint 

Step 1 Select the fingerprint option.

Step 2 Tap the finger that you will be enrolling.

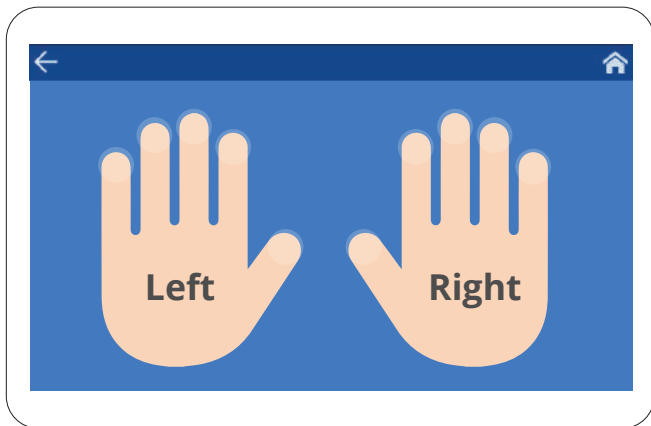

Step 3 Scan the finger you are enrolling 3 individual times. Once the process is complete, the enrolled finger will be marked on the corresponding hand.

For detailed instructions and proper finger placement when Scanning your fingerprint, refer to page **22**

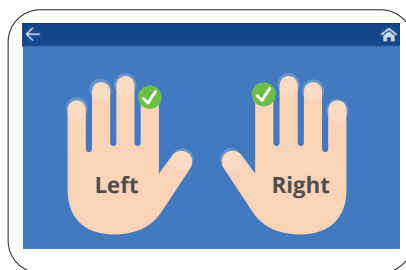
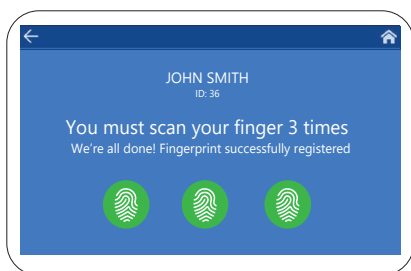

II. Proximity

Step 1 Select the Proximity card option

Step 2 Scan your card by placing it near the  icon located on the right side of Xenio time clock

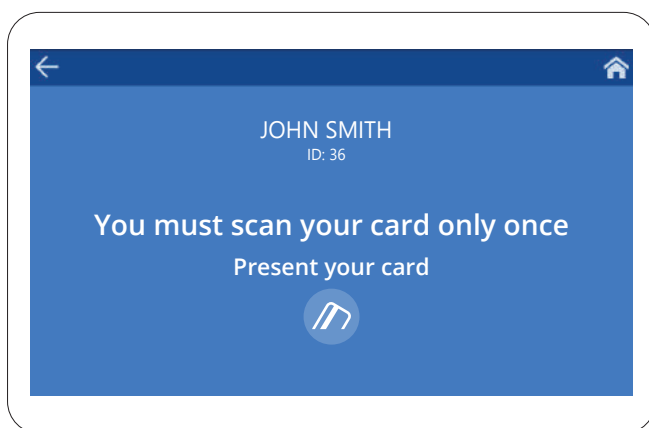

III. Passcode

Step 1 Select the passcode option.

Step 2 Enter your passcode. 4-6 characters in length.

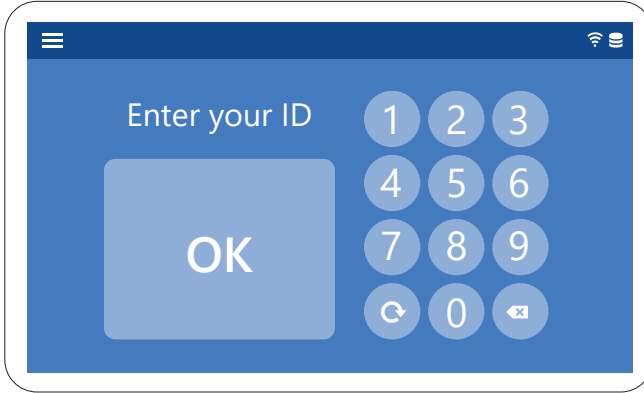

Once you have successfully enrolled the User, they may begin clocking in/out on the Xenio Smart Clock.

NOTE:

To remove a User from the Xenio Time Clock, log into your software and remove the user's Clocking Permissions to the device.

To delete a User from the Xenio Smart Clock, inactivate or terminate the User directly from the Easy Clocking software

Assigning Administrator/Manager Level

The Xenio's default setting allows anyone open access into the Menu.

To restrict access, user levels can be specified as **Administrator** or **Manager**. Setting these restrictions will only allow authorized users to open the device Menu.

Level Description

- **Employee:** Can only clock in or out, cannot access the Time Clock Menu.
- **Manager:** Can access the Menu to add Employees, view employee Schedules, Time Records and Jobs as well as configure the Wi-Fi connection. Prevented from accessing a few Network and Time Clock Settings
- **Administrator:** Has full access to the Menu and all settings.

How to Set the Admin/Manager Level

Enroll the employee as shown in the previous pages of this guide, before following the steps below.

To create a Manager or Administrator on the Time Clock, log into your software and navigate to:

1. **Users**

2. **Clocking Permissions:**

- In the section for Time Clock Permissions, specify the Time Clock Menu Level.
- Select between Administrator and Manager to apply the Menu restriction on the Xenio Smart Clock.
- Click **SAVE** to apply the change.

NOTE:

The Xenio Time Clock must be online and connected to a Network in order to send this command.

Once you have specified the restriction level, the following message will appear on the device when attempting to open the Menu:

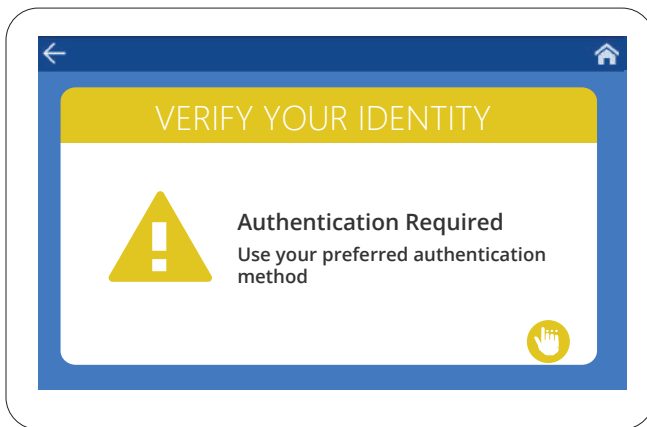

Verify yourself as the Administrator or Manager by scanning your fingerprint or other method of verification. (I.e. Passcode or Proximity Card.)

How to Properly Clock In/Out with Fingerprints

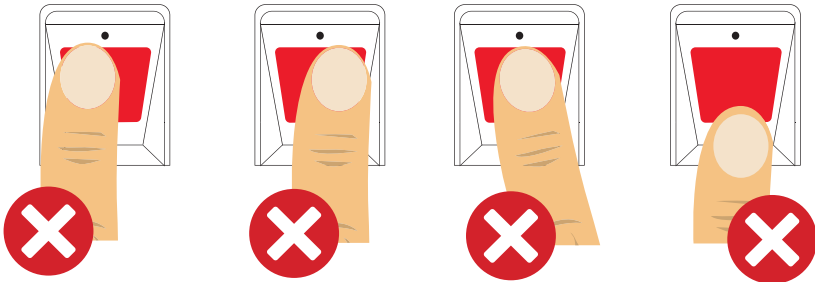
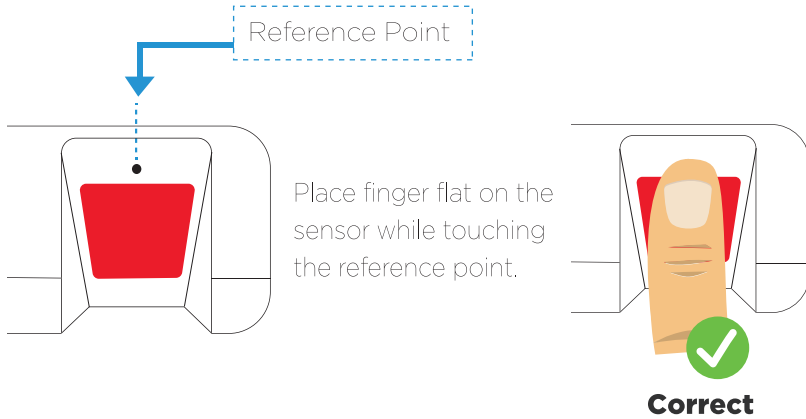

Once the employee successfully clocks in or out, a "Verified" prompt will appear displaying the employee ID number, name and entry time.

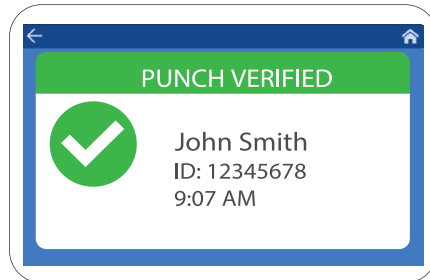

How to Properly Clock In/Out with Smart Card



1. Place the card in front of the time clock's card reader  icon.

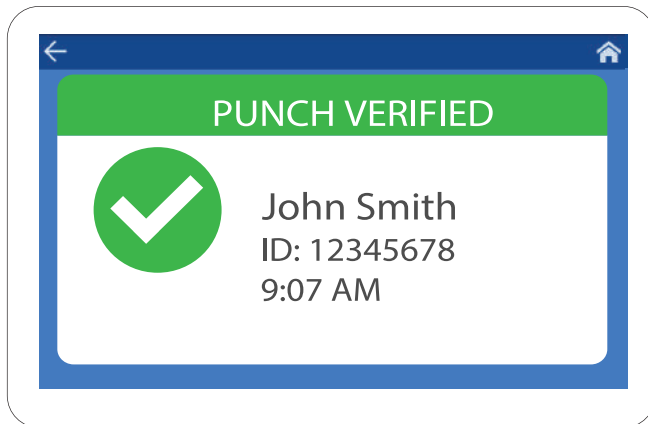

2. Once the employee successfully clocks in or out, a "Verified" prompt will appear displaying the employee ID number, name and entry time.



How to Clock In/Out (Pin Number)

1. Enable the passcode option for clocking in/out on the home screen of the Xenio by navigating to:
 1. Open the Xenio Time Clock Menu 
 2. Select *Settings* 
 3. Scroll to Select *Pin Settings*  **Pin Settings**
 4. Select *Allowed*.

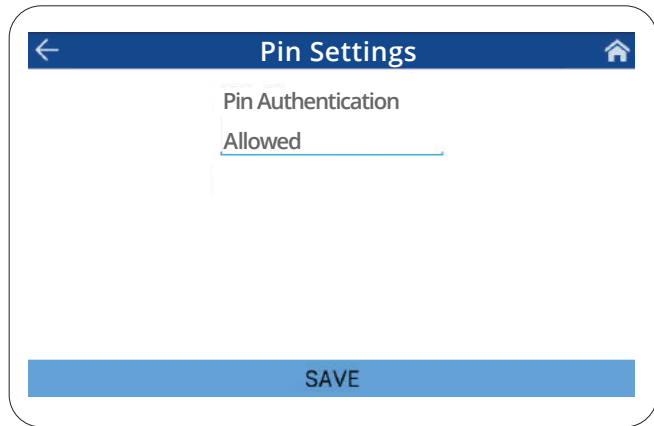

Once the option is verified/enabled, you will see the Pin Code icon on the main screen.

Click 

Continue to the following page to see more instructions.

1. Enter your *User ID* and Select *OK*

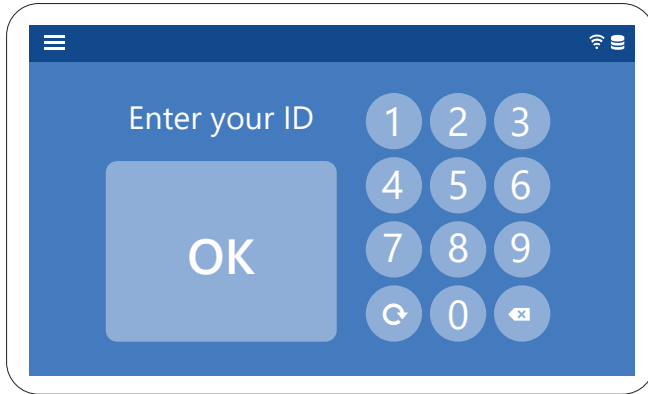

2. Enter your ***Personal Identification Number*** (PIN code)

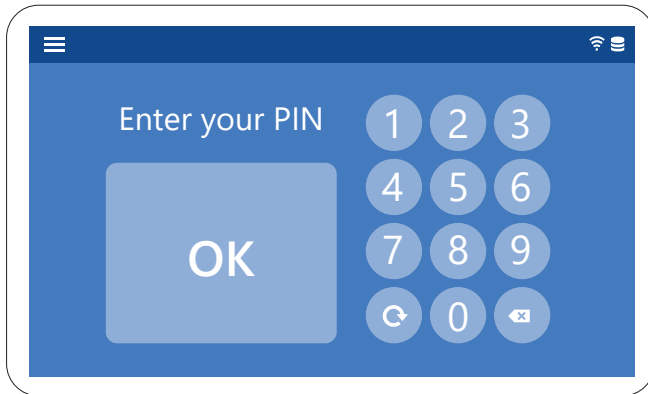

3. Select *OK*

System Settings

Updates

Menu > Settings > Updates

- To run updates, select the available updates and tap **RUN** on the bottom of the Window Pane.

UI Theme

Menu > Settings > UI Theme

- Select the color theme for your Xenio Smart Clock.
- Click **SAVE** to apply any changes.

Language

Menu > Settings > Language

- From the drop-down list, select the default Time Clock language
- Click **SAVE** to apply any changes.

Date and Time

Menu > Settings > Date and Time

- You may modify the Date format and the Time format.
- The Date and Time are changed directly from the Software, according to the selected Time Zone.
- The Xenio must be **ONLINE** (connected to an internet connection) in order to receive any command from the Software.
- Click **SAVE** to apply any changes.

Display

Menu > Settings > Display

- Configure Sleep settings on the Xenio Smart Clock.
You can set the screen to time-out after the specified amount of time.
- Set the Brightness level.
- Click **SAVE** to apply any changes.

Audio

Menu > Settings > Audio

- Control the Volume level
- Control Touch Sound setting.
- Click **SAVE** to apply any changes.

Thank you for choosing Easy Clocking!

We value you greatly as a customer and hope to bring great value to your organization.

At Easy Clocking, we believe that our values make us. Below are the simple yet powerful values we strive for everyday.

Serving customers. A proud acknowledgement that their success is our success.

Intellectual **honesty**. A sincere attempt at all times to support the best idea and solution.

Team wins. A team attitude that extends trust, respect and support in all interactions and to work together on tasks in order to win.

Dedication to values. An unwavering commitment to quality, professionalism and ethics in everything we do.

Passion for results. A result oriented focus, to bring discussion and decisions to real and tangible results through action.

EASY CLOCKING TECHNICAL SUPPORT

Phone: 1300 693 610

Email: support@easyclocking.com.au